

天海汽车电子集团股份有限公司
Tianhai Auto Electronics Group Co., Ltd.

地址：中国河南省鹤壁市松江路003号
 邮编：458030
 销售热线：186 0392 8607
 市场热线：0392-3288299
 市场邮箱：ljq_marketing@thb.com.cn
 网址：www.thb.com.cn

Address: No. 003, Songjiang Road, Hebi City, Henan Province, China
 Postal code: 458030
 Sales hotline: 186 0392 8607
 Market hotline: 0392-3288299
 Market Email: ljq_marketing@thb.com.cn
 Http:// www.thb.com.cn



**致力于成为全球一流的汽车电子电器系统供应商
 为民族品牌助力**

Committed to becoming a world-class supplier of automotive electronics and electrical systems and assist national brands.

营销网络及联系方式

MARKETING NETWORK AND CONTACT INFORMATION

公司名称	业务经理	联系电话	邮箱
天海集团连接器本部销售部	朱经理	18603928607	zhuhongxing@thb.com.cn
上海鹤壁电器有限公司	任经理	18501671403	renweihua@shthb.com
南京鹤壁天海电器有限公司	高经理	15651788861	gaohuaizhong@thb.com.cn
武汉鹤壁天海电器有限公司	张经理	18603929206	zhangbingwei@thb.com.cn
广州天海电器实业有限公司	张经理	18520131391	zhanghehe@gzthb.com
济南天海电器有限公司	康经理	18615698828	kanghaomin@thb.com.cn
重庆天海电器销售有限公司	李经理	18680863236	lifeng@thb.com.cn
长春办事处	刘经理	13603920377	liuhengling@thb.com.cn
郑州办事处	李经理	18603929228	lishanke@thb.com.cn
合肥办事处	秦经理	18639246985	qinwei@thb.com.cn
柳州办事处	李经理	15539219677	liguolin@thb.com.cn
北京办事处	白经理	13569125792	baizhouqi@thb.com.cn
芜湖办事处	秦经理	18639246985	qinwei@thb.com.cn
高速连接器及摩托车连接器客户经理	李经理	18603929228	lishanke@thb.com.cn
连接器国际业务经理	刘经理	18639226836	liuxin@thb.com.cn



**THB TH-C INLINE连接
 解决方案2025版**

公司简介

Company Profile

◎行业龙头

天海集团是实力雄厚的连接器科研生产企业和新兴的汽车电子产品研发生产企业，先后荣获“中国驰名商标”“国家级绿色工厂”“全国质量标杆企业”“高新技术企业”“中国汽车零部件（连接器）龙头企业”“河南省长质量奖”等荣誉称号。2020年，天海汽车线束行业5G+工业互联网入选河南省工业互联网平台培育对象。

Industry leader: As a strong R&D and production base for connectors and automotive electronics, THB Group has won honors such as China Well-Known Trademark, National Green Factory, National Quality Benchmarking Enterprise, High-tech Enterprise, Leading Enterprise of China Auto Parts(Connectors), and Henan Provincial Governor Quality Award etc. In 2020, THB 5G automotive harness industry and industrial internet project was selected as one of cultivation projects of Henan Provincial industrial Internet Platform.

◎产品标准制定者

主持制定《车用电线束插接器》、《车用中央电气接线盒》、《汽车熔断器》、《电动汽车传导式充电接口》等30多项国家或行业标准。

Drafter of Product Standards: THB Group has drafted more than 30 national or industrial standards such as: Connectors for Automotive Wiring Harness, Junction Box for Automotive Central Electric, Automotive Fuse, Conductive Charging Interface for Electrical Vehicle etc.

◎全球营销网络

在全球拥有36个销售办事处，与国际主流汽车制造厂商建立合作关系。

Global Marketing Network: THB has 36 sales offices around the world and has established cooperative relations with major international auto giants in the world.

◎体系管理

全面推行IATF16949、ISO14001、ISO50001、ISO45001、六西格玛、ERP系统、全面预算管理。

System Management: THB Group implements ISO/TS16949, ISO14001, ISO50001, ISO45001, Six Sigma, ERP system, comprehensive budget management etc. in an all-round way.

◎客户文化

建立“以客户为中心，以绩效为导向”的企业文化。

Customer Culture: THB Group establishes “Customer Centered, Performance Oriented” corporate culture.



THB
中国驰名商标



国家高新技术企业

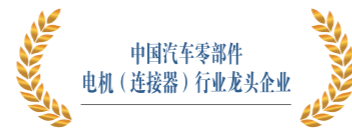

中国汽车零部件
电机（连接器）行业龙头企业

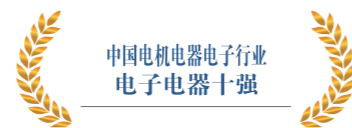

中国电机电器电子行业
电子电器十强



◎业务规划

“十四五”规划合并营收突破百亿，实现百亿天海，新能源业务占比超过50%，成功实现与汽车行业的同步转型。

Rapid Growth: The combined revenue of the "14th Five-Year Plan" plan to exceeded 10 billion and achieve the "10 Billion THB". The new energy business accounted for more than 50%, successfully realizing the simultaneous transformation with the automotive industry.

◎客户荣誉

在国际市场，连续4年被评为美国通用“全球优秀供应商”，深受国内知名自主品牌的广泛赞赏。

Customer Honors: In the international market, it has been rated as the "Global Excellent Supplier" of General Motors of the United States THB Group gets widespread praise from well-known self-owned brands domestically.



奇瑞卓越合作协同奖
CHERY Excellent Cooperation Award



蔚来守望奖
NIO Overwatch Award



理想精神奖
Li Auto Spirit Award



2024 质量最佳表现供应商
The Best Quality Performance Supplier of 2024

目录 Catalogue

○ THB TH-C防水系列/ TH-C Sealed Series Connectors.....P4

端子 Terminals						
规格 SPEC	064	150	280			
页码 Page	P4	P4	P5			
连接器 Connectors						
页码 Page 规格 SPEC 孔数 Hole No	064	150	280	064+150	064+150+280	
2	P6	P8	P12			
3		P8				
4	P6	P9	P12			
6		P9				
8	P7	P10				
10		P10				
12		P11				
18 (14+4)				P13		
24 (18+6)				P14		
30 (20+6+4)						P15
44 (30+8+6)						P16
类型 Type	密封堵 Cable Seal		盲堵 Seal Block			
页码 Page	P17		P17			

○ THB TH-C非防水系列/ TH-C Unsealed Series Connectors.....P18

端子 Terminals					
规格 SPEC	064	150	280		
页码 Page	P18	P19	P19		
连接器 Connectors					
页码 Page 规格 SPEC 孔数 Hole No	064	150	280	150+280	064+150+280
2		P20	P22		
4			P22		
6		P20			
10		P21			
14		P21			
16 (12+4)				P23	
20		P21			
26 (16+6+4)					P24
37 (31+4+2)					P25
42 (20+14+8)					P25
辅件 Accessories					
类型 Type	A型卡扣 Clip -Type A	B型卡扣 Clip -Type B	C型卡扣 Clip -Type C		
页码 Page	P26	P27	P27		

TH-C 系列防水连接器 TH-C Sealed Series Connectors

◎ 性能参数/Specification

工作电压/Working Voltage	60V DC max
工作电流/Working Current	TH-064 7A max TH-150 18A max TH-280 27A max
接触电阻/Contact resistance	TH-064 20mΩ max TH-150 10mΩ max TH-280 5mΩ max
插拔次数/Mating Cycles	10
温度范围/Temperature Range	-40 °C ~ 125 °C
振动等级/Vibration Classification	V2 (QC/T 1067.1-2017/USCAR2)
防水等级/Sealing Classification	S2 (QC/T 1067.1-2017/USCAR2)
环保要求/ Environmental Requirements	ELV / ROHS

TH-064 防水端子 / Th-064 Sealed Terminal

○ 插头端子/ Male Terminal

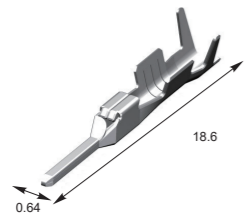

零件号 Part No.	材质 Material	通电电流(A) Current(A)	适配导线(mm ²) Wire Range(mm ²)
0149601	黄铜 Brass	5	0.22-0.35
0149602	黄铜 Brass	7	0.5

○ 插座端子/ Female Terminal

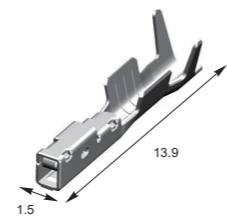

零件号 Part No.	材质 Material	通电电流(A) Current(A)	适配导线(mm ²) Wire Range(mm ²)
0149701	铜合金 Copper Alloy	5	0.22-0.35
0149702	铜合金 Copper Alloy	7	0.5

TH-150 防水端子 / TH-150 Sealed Terminal

○ 插头端子/ Male Terminal

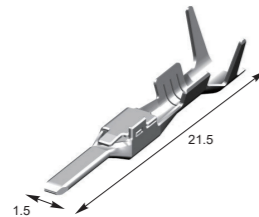

零件号 Part No.	材质 Material	通电电流(A) Current(A)	适配导线(mm ²) Wire Range(mm ²)
0150001	黄铜 Brass	8	0.35-0.5
0150002	黄铜 Brass	13	0.75-1.25
0150003	黄铜 Brass	18	1.5-2.0

○ 插座端子/ Female Terminal

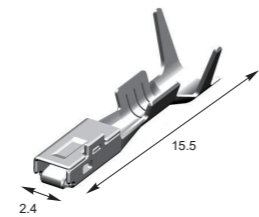

零件号 Part No.	材质 Material	通电电流(A) Current(A)	适配导线(mm ²) Wire Range(mm ²)
0150101	铜合金 Copper Alloy	8	0.35-0.5
0150102	铜合金 Copper Alloy	13	0.75-1.25
0150103	铜合金 Copper Alloy	18	1.5-2.0

TH-280 防水端子 / TH-280 Sealed Terminal

○ 插头端子/ Male Terminal

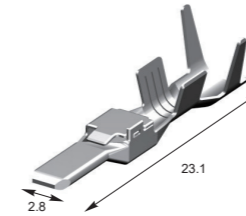

零件号 Part No.	材质 Material	通电电流(A) Current(A)	适配导线(mm ²) Wire Range(mm ²)
0150401	黄铜 Brass	8	0.35-0.5
0150402	黄铜 Brass	13	0.75-1.25
0150403	黄铜 Brass	18	1.5-2.0
0150404	黄铜 Brass	27	2.5-3.0

○ 插座端子/ Female Terminal

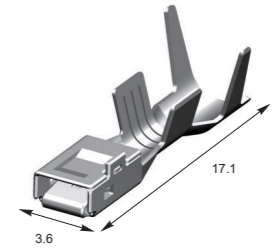

零件号 Part No.	材质 Material	通电电流(A) Current(A)	适配导线(mm ²) Wire Range(mm ²)
0150501	铜合金 Copper Alloy	8	0.35-0.5
0150502	铜合金 Copper Alloy	13	0.75-1.25
0150503	铜合金 Copper Alloy	18	1.5-2.0
0150504	铜合金 Copper Alloy	27	2.5-3.0

TH-064 防水护套 / TH-064 Sealed Housing

◎ 产品结构/ Construction

◆ 常规型/Normal

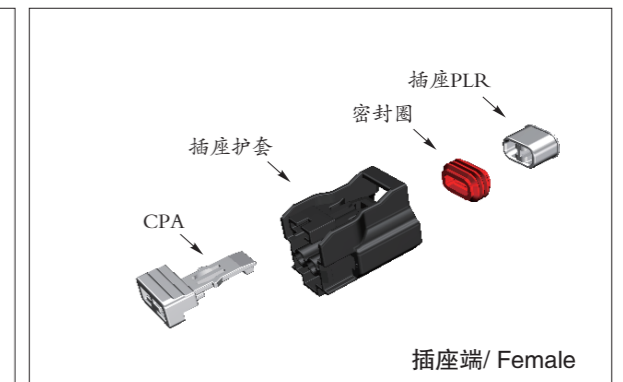
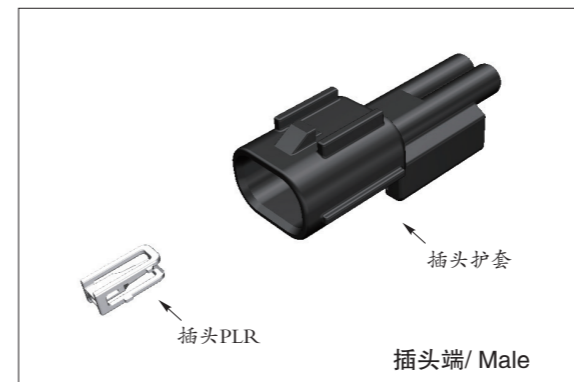

◆ 过孔型/ Through-Hole

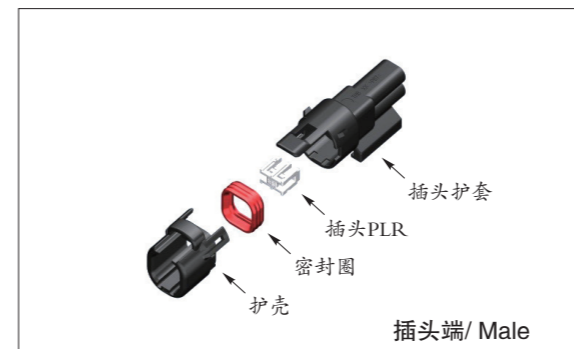

◎ 系列产品 / Series Product

◆ 常规型 / Normal

○ 插头护套 / Male Housing

2线

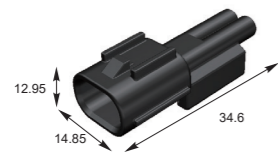

○ 插座护套 / Female Housing



适配A型卡扣 / Mating Type A Clip

零件号 Part No.	颜色 Color	防错 Coding	零件号 Part No.	颜色 Color	防错 Coding
1578001	黑色 Black	A	1578101	黑色 Black	A
1578002	灰色 Gray	B	1578102	灰色 Gray	B
1578003	棕色 Brown	C	1578103	棕色 Brown	C
1578004	绿色 Green	D	1578104	绿色 Green	D
			1578112 (无CPA/No CPA)	黑色 Black	A
			1578113 (无CPA/No CPA)	灰色 Gray	B
			1578114 (无CPA/No CPA)	棕色 Brown	C
			1578115 (无CPA/No CPA)	绿色 Green	D
			1578111 (PLR)	本色 Natural	

推荐位置: 低频天线、防夹开关、牌照灯、车身对接、信号传输
Recommended Location: low frequency antenna, anti-pinch switch, license plate light, body docking, signal transmission

◆ 过孔型 / Through-Hole

○ 插头护套 / Male Housing

4线



○ 插座护套 / Female Housing

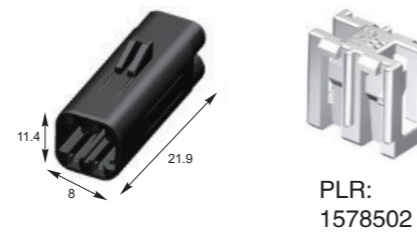

适配A型卡扣 / Mating Type A Clip

零件号 Part No.	颜色 Color	防错 Coding	零件号 Part No.	颜色 Color	防错 Coding
1578401	黑色 Black		1578501	黑色 Black	
			1578502 (PLR)	本色 Natural	

推荐位置: 天线、360全景摄像头、车身对接、信号传输等
Recommended Location: antenna, 360 panoramic camera, body docking, signal transmission, etc

○ 插头护套 / Male Housing

8线



○ 插座护套 / Female Housing

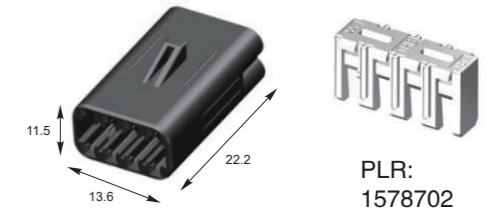

适配A型卡扣 / Mating Type A Clip

零件号 Part No.	颜色 Color	防错 Coding	零件号 Part No.	颜色 Color	防错 Coding
1578601	黑色 Black		1578701	黑色 Black	
			1578702 (PLR)	本色 Natural	

推荐位置: 倒车摄像头、门把手开关、车身对接、信号传输等
Recommended Location: reverse camera, door knob switch, body docking, signal transmission, etc

TH-150 防水护套 / TH-150 Sealed Housing

◎ 产品结构 / Construction

◆ 常规型 / Normal

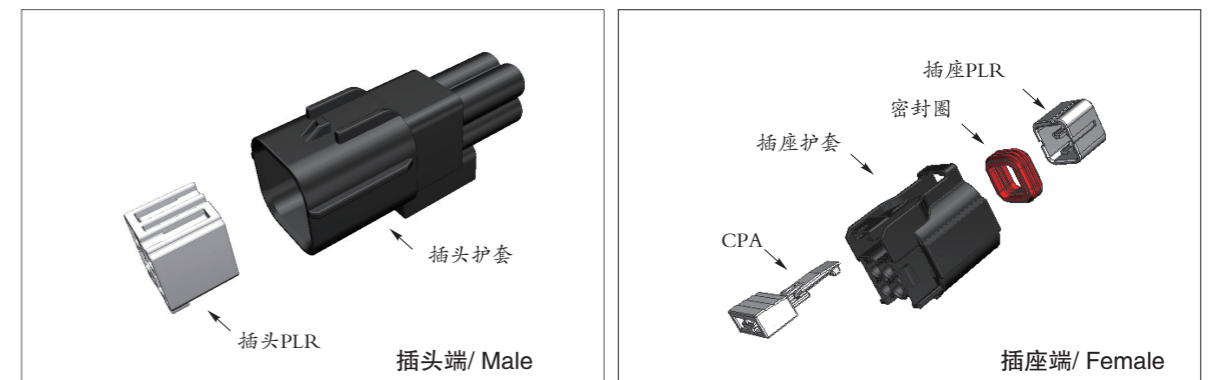

◎ 系列产品 / Series Product

○ 插头护套 / Male Housing

2线

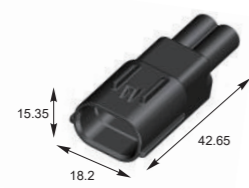

适配A型卡扣/Mating Type A Clip

零件号 Part No.	颜色 Color	防错 Coding
1578801	黑色 Black	A
1578802	灰色 Gray	B
1578803	棕色 Brown	C

推荐位置: 车身对接、信号传输、电源等
Recommended Location: body docking, signal transmission or power supply

○ 插座护套 / Female Housing

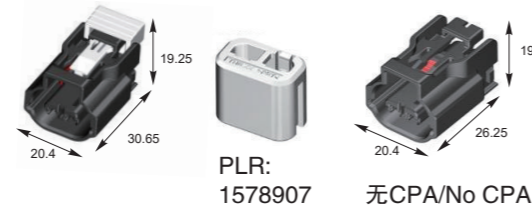

零件号 Part No.	颜色 Color	防错 Coding
1578901	黑色 Black	A
1578902	灰色 Gray	B
1578903	棕色 Brown	C
1578909 (无CPA/No CPA)	黑色 Black	A
1578910 (无CPA/No CPA)	灰色 Gray	B
1578911 (无CPA/No CPA)	棕色 Brown	C
1578907 (PLR)	本色 Natural	

○ 插头护套 / Male Housing

3线

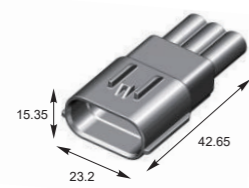

适配A型卡扣/Mating Type A Clip

零件号 Part No.	颜色 Color	防错 Coding
1579001	黑色 Black	A
1579002	灰色 Gray	B
1579003	棕色 Brown	C

推荐位置: 车身对接、信号传输、电源等
Recommended Location: body docking, signal transmission or power supply

○ 插座护套 / Female Housing

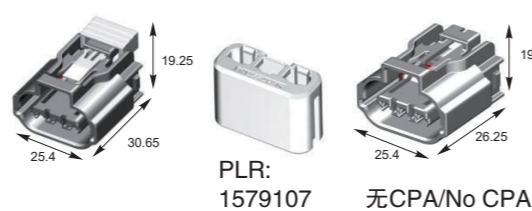

零件号 Part No.	颜色 Color	防错 Coding
1579101	黑色 Black	A
1579102	灰色 Gray	B
1579103	棕色 Brown	C
1579109 (无CPA/No CPA)	黑色 Black	A
1579110 (无CPA/No CPA)	灰色 Gray	B
1579111 (无CPA/No CPA)	棕色 Brown	C
1579107 (PLR)	本色 Natural	

○ 插头护套 / Male Housing

4线

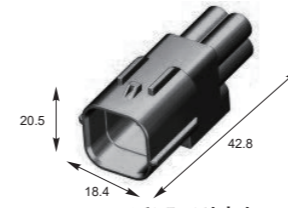

适配A型卡扣/Mating Type A Clip

零件号 Part No.	颜色 Color	防错 Coding
1572801	黑色 Black	A
1572802	灰色 Gray	B
1572803	棕色 Brown	C
1572804	绿色 Green	D
1572805	蓝色 Blue	E
1572806	本色 Natural	F

推荐位置: 急停开关、尾灯、车身对接、信号传输等
Recommended Location: scram switch, taillight, body docking, signal transmission, etc

○ 插座护套 / Female Housing



零件号 Part No.	颜色 Color	防错 Coding
1572901 (无CPA/No CPA)	黑色 Black	A
1572902 (无CPA/No CPA)	灰色 Gray	B
1572903 (无CPA/No CPA)	棕色 Brown	C
1572904 (无CPA/No CPA)	绿色 Green	D
1572905 (无CPA/No CPA)	蓝色 Blue	E
1572906 (无CPA/No CPA)	本色 Natural	F
1572916	黑色 Black	A
1572917	灰色 Gray	B
1572918	棕色 Brown	C
1572919	绿色 Green	D
1572920	蓝色 Blue	E
1572921	本色 Natural	F
1572913 (PLR)	本色 Natural	

○ 插头护套 / Male Housing

6线

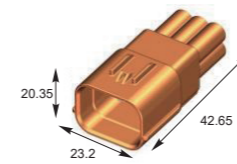

适配A型卡扣/Mating Type A Clip

零件号 Part No.	颜色 Color	防错 Coding
1579201	黑色 Black	A
1579202	灰色 Gray	B
1579203	棕色 Brown	C

推荐位置: 车身对接、信号传输、电源等
Recommended Location: body docking, signal transmission or power supply

○ 插座护套 / Female Housing

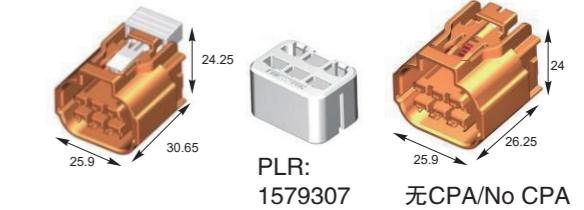

零件号 Part No.	颜色 Color	防错 Coding
1579301	黑色 Black	A
1579302	灰色 Gray	B
1579303	棕色 Brown	C
1579309 (无CPA/No CPA)	黑色 Black	A
1579310 (无CPA/No CPA)	灰色 Gray	B
1579311 (无CPA/No CPA)	棕色 Brown	C
1579307 (PLR)	本色 Natural	

◎ 系列产品 / Series Product

○ 插头护套 / Male Housing

2线

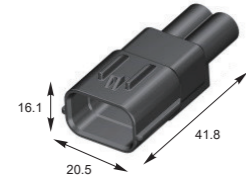

适配A型卡扣 / Mating Type A Clip

零件号 Part No.	颜色 Color	防错 Coding	零件号 Part No.	颜色 Color	防错 Coding
1580001	黑色 Black	A	1580101 (无CPA/No CPA)	黑色 Black	A
1580002	灰色 Gray	B	1580102 (无CPA/No CPA)	灰色 Gray	B
1580003	棕色 Brown	C	1580103 (无CPA/No CPA)	棕色 Brown	C
			1580109	黑色 Black	A
			1580110	灰色 Gray	B
			1580111	棕色 Brown	C
			1580107 (PLR)	本色 Natural	

推荐位置: 前后雾灯、车身对接、信号传输、电源等
Recommended Location: front and rear fog lights, body docking, signal transmission, power supply, etc

○ 插头护套 / Male Housing

4线

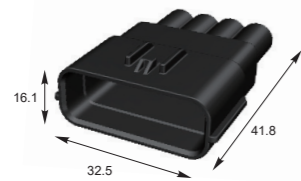

适配A型卡扣 / Mating Type A Clip

零件号 Part No.	颜色 Color	防错 Coding	零件号 Part No.	颜色 Color	防错 Coding
1580201	黑色 Black	A	1580301 (无CPA/No CPA)	黑色 Black	A
1580202	灰色 Gray	B	1580302 (无CPA/No CPA)	灰色 Gray	B
1580203	棕色 Brown	C	1580303 (无CPA/No CPA)	棕色 Brown	C
			1580309	黑色 Black	A
			1580310	灰色 Gray	B
			1580311	棕色 Brown	C
			1580307 (PLR)	本色 Natural	

推荐位置: 空气压力开关、车身对接、信号传输、电源等
Recommended Location: air pressure switch, body docking, signal transmission, power supply, etc

○ 插座护套 / Female Housing



TH-064+150 混合防水护套 / TH-064+150 Hybrid Sealed Housing

◎ 产品结构 / CONSTRUCTION

◆ 常规型 / Normal

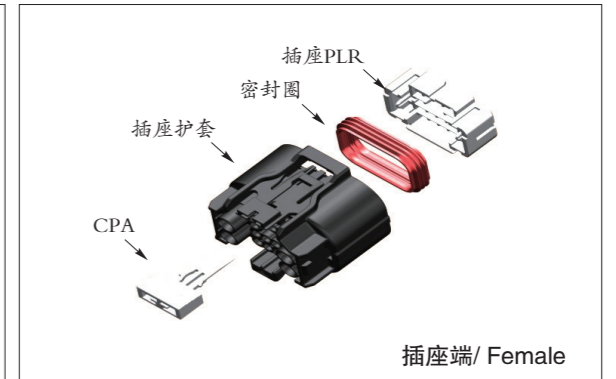

◎ 系列产品 / Series Product

○ 插头护套 / Male Housing

18线 (0.64*0.64x14; 1.5*0.64x4)



适配A型卡扣 / Mating Type A Clip

零件号 Part No.	颜色 Color	防错 Coding	零件号 Part No.	颜色 Color	防错 Coding
1580401	黑色 Black	A	1580501 (无CPA/No CPA)	黑色 Black	A
1580402	灰色 Gray	B	1580502 (无CPA/No CPA)	灰色 Gray	B
1580403	棕色 Brown	C	1580503 (无CPA/No CPA)	棕色 Brown	C
			1580509	黑色 Black	A
			1580510	灰色 Gray	B
			1580511	棕色 Brown	C
			1580507 (PLR)	本色 Natural	

推荐位置: 前后保、车身对接、信号传输、电源等
Recommended Location: front and rear protection, body docking, signal transmission, power supply, etc

○ 插座护套 / Female Housing

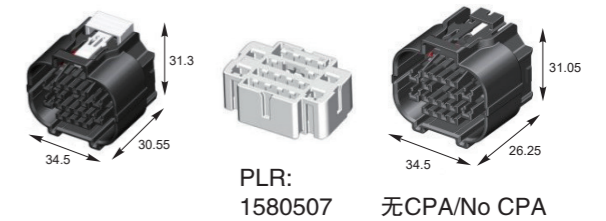

○ 插头护套/ Male Housing

24线 (0.64*0.64x18;1.5*0.64x6)



适配A型卡扣/Mating Type A Clip

零件号 Part No.	颜色 Color	防错 Coding	零件号 Part No.	颜色 Color	防错 Coding
1580601	黑色 Black	A	1580701 (无CPA/No CPA)	黑色 Black	A
1580602	灰色 Gray	B	1580702 (无CPA/No CPA)	灰色 Gray	B
1580603	棕色 Brown	C	1580703 (无CPA/No CPA)	棕色 Brown	C
			1580709	黑色 Black	A
			1580710	灰色 Gray	B
			1580711	棕色 Brown	C
			1580707 (PLR)	本色 Natural	

推荐位置: 前后保、车身对接、信号传输、电源等
Recommended Location: front and rear protection, body docking, signal transmission, power supply, etc

○ 插座护套/ Female Housing

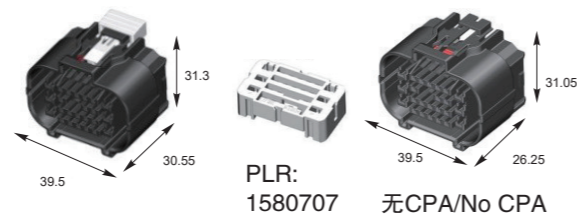

TH-064+150+280 混合防水护套 / TH-064+150+280 Hybrid Sealed Housing

◎ 产品结构/ Construction

◆ 常规型/Normal

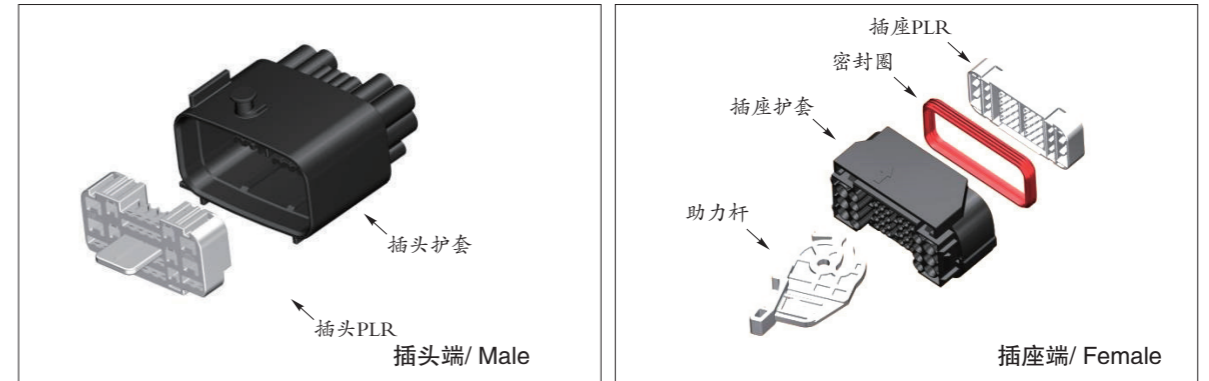

◎ 系列产品/Series Product

○ 插头护套/ Male Housing

30线 (0.64*0.64x20;1.5*0.64x6;2.8*0.8x4)

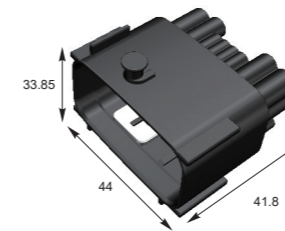

适配C型卡扣或钣金/Mating Type C Clip

零件号 Part No.	颜色 Color	防错 Coding	零件号 Part No.	颜色 Color	防错 Coding
1564201	黑色 Black	A	1564301	黑色 Black	A
1564202	灰色 Gray	B	1564302	灰色 Gray	B
1564203	棕色 Brown	C	1564303	棕色 Brown	C
1564204	绿色 Green	D	1564304	黑色 Black	D
1564205	蓝色 Blue	E	1564305	灰色 Gray	E
1564206	本色 Natural	F	1564306	棕色 Brown	F
			1564313 (PLR)	本色 Natural	

推荐位置: 前舱、发动机、车身对接、信号传输、电源等
Recommended Location: front cabin, engine, body docking, signal transmission, power supply, etc

○ 插座护套/ Female Housing

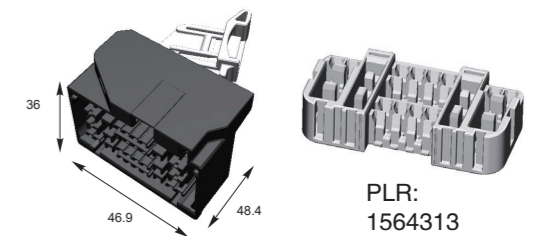

○ 插头护套/ Male Housing

44线 (0.64*0.64x30;1.5*0.64x8;2.8*0.8x6)

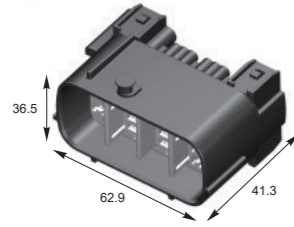

适配C型卡扣或钣金/Mating Type C Clip

零件号 Part No.	颜色 Color	防错 Coding	零件号 Part No.	颜色 Color	防错 Coding
1580801	黑色 Black	A	1580901	黑色 Black	A
1580802	灰色 Gray	B	1580902	灰色 Gray	B
1580803	棕色 Brown	C	1580903	棕色 Brown	C
			1580907 (PLR)	本色 Natural	

推荐位置: 前舱、发动机、车身对接、信号传输、电源等
Recommended Location: front cabin, engine, body docking, signal transmission, power supply, etc

○ 插座护套/ Female Housing

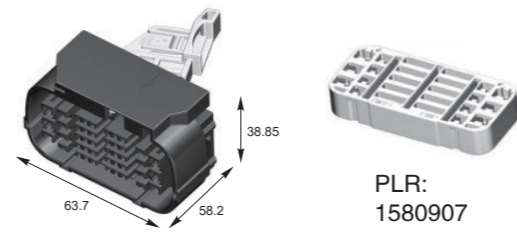

◎ 适配密封堵信息/ Cable Seal Information

规格 SPEC	外形尺寸 Size	零件号 Part No.	颜色 Color	适用导线外径 (mm) FIT Wire DIM
064		2053801	深灰色 Dark Gray	1.1-1.4
		2053802	蓝色 Blue	1.4-1.6
150		2053301	橘红色 Orange-Red	1.2-1.8
		2053302	绿色 Green	1.5-2.1
		2053303	棕色 Brown	2.2-3.0
280		2053501	蓝色 Blue	1.2-1.7
		2053502	青色 Cyan	1.6-2.2
		2053503	深绿色 Dark Green	2.1-2.8
		2053504	灰色 Gray	2.7-3.0
		2053505	黄色 Yellow	3.0-3.8

◎ 适配盲堵信息/ Seal Block Information

规格 SPEC	外形尺寸 Size	零件号 Part No.	颜色 Color	适用护套孔径 (mm) FIT Hole DIM.
064		2053201	浅灰色 Light Gray	Φ2.6
150		2053401	黑色 Black	Φ4.5
280		2053601	紫色 Purple	Φ5.5

TH-C系列非防水连接器 TH-C Unsealed Series Connectors

◎ 性能参数/Specification

工作电压/Working Voltage	60V DC max
工作电流/Working current	TH-064 7A max TH-150 18A max TH-280 27A max
接触电阻/Contact resistance	TH-064 20mΩ max TH-150 10mΩ max TH-280 5mΩ max
插拔次数/Mating Cycles	10
温度范围/Temperature Range	-40 °C ~ 100 °C
振动等级/Vibration Classification	V1 (QC/T 1067.1-2017/USCAR2)
防水等级/Sealing Classification	S1 (QC/T 1067.1-2017/USCAR2)
环保要求/ Environmental Requirements	ELV / ROHS

TH-064 非防水端子 / TH-064 Unsealed Terminal

○ 插头端子/ Male Terminal

○ 插座端子/ Female Terminal

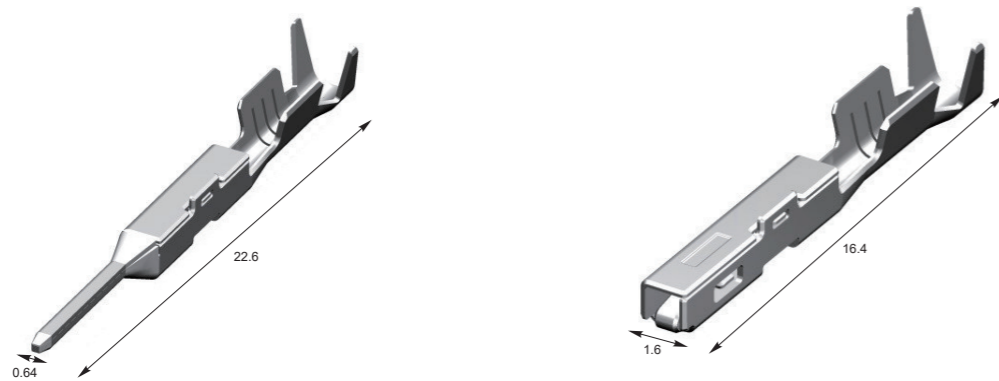

零件号 Part No.	材质 Material	通电电流(A) Current(A)	适配导线(mm ²) Wire Range(mm ²)	零件号 Part No.	材质 Material	通电电流(A) Current(A)	适配导线(mm ²) Wire Range(mm ²)
0149401	铜合金 Copper Alloy	3.5	0.13-0.22	0149501	铜合金 Copper Alloy	3.5	0.13-0.22
0149402	铜合金 Copper Alloy	5	0.3-0.35	0149502	铜合金 Copper Alloy	5	0.3-0.35
0149403	铜合金 Copper Alloy	7	0.5	0149503	铜合金 Copper Alloy	7	0.5

TH-150 非防水端子 / TH-150 Unsealed Terminal

○ 插头端子/ Male Terminal

○ 插座端子/ Female Terminal



零件号 Part No.	材质 Material	通电电流(A) Current(A)	适配导线(mm ²) Wire Range(mm ²)	零件号 Part No.	材质 Material	通电电流(A) Current(A)	适配导线(mm ²) Wire Range(mm ²)
0149801	铜合金 Copper Alloy	8	0.35-0.5	0149901	铜合金 Copper Alloy	8	0.35-0.5
0149802	铜合金 Copper Alloy	13	0.75-1.25	0149902	铜合金 Copper Alloy	13	0.75-1.25
0149803	铜合金 Copper Alloy	18	1.5-2.0	0149903	铜合金 Copper Alloy	18	1.5-2.0

TH-280 非防水端子 / TH-280 Unsealed Terminal

○ 插头端子/ Male Terminal

○ 插座端子/ Female Terminal

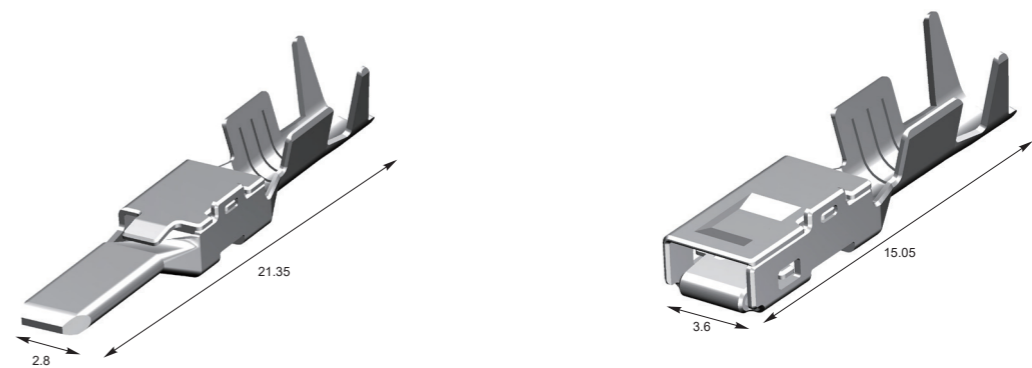

零件号 Part No.	材质 Material	通电电流(A) Current(A)	适配导线(mm ²) Wire Range(mm ²)	零件号 Part No.	材质 Material	通电电流(A) Current(A)	适配导线(mm ²) Wire Range(mm ²)
0150201	铜合金 Copper Alloy	8	0.35-0.5	0150301	铜合金 Copper Alloy	8	0.35-0.5
0150202	铜合金 Copper Alloy	13	0.75-1.25	0150302	铜合金 Copper Alloy	13	0.75-1.25
0150203	铜合金 Copper Alloy	18	1.5-2.0	0150303	铜合金 Copper Alloy	18	1.5-2.0
0150204	铜合金 Copper Alloy	27	2.5-3.0	0150304	铜合金 Copper Alloy	27	2.5-3.0

TH-150 非防水护套 / TH-150 Unsealed Housing

◎ 产品结构 / Construction

◆ 常规型 / Normal

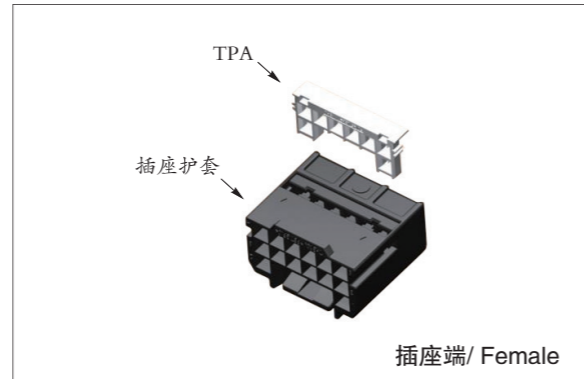

◎ 系列产品 / Series Product

○ 插头护套 / Male Housing

2线

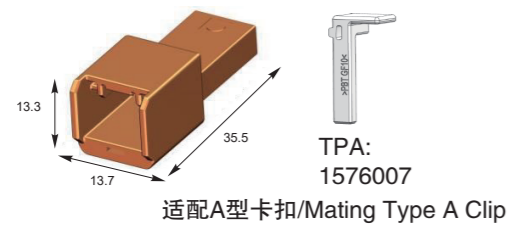

零件号 Part No.	颜色 Color	防错 Coding
1576004	黑色 Black	A
1576005	本色 Natural	B
1576006	棕色 Brown	C
1576007 (TPA)	本色 Natural	

推荐位置：车身对接、信号传输、电源等
Recommended Location: body docking, signal transmission or power supply

○ 插头护套 / Male Housing

6线

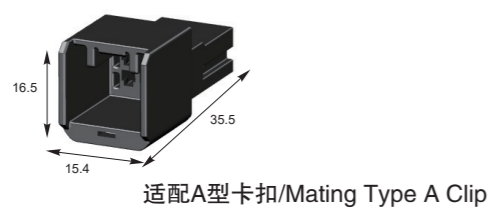

零件号 Part No.	颜色 Color	防错 Coding
1576201	黑色 Black	A
1576202	灰色 Gray	B
1576203	棕色 Brown	C

推荐位置：车身对接、信号传输、电源等
Recommended Location: body docking, signal transmission or power supply

○ 插座护套 / Female Housing

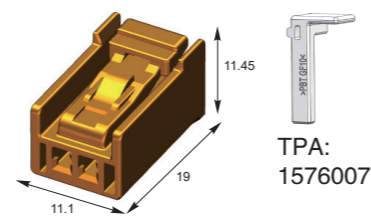

零件号 Part No.	颜色 Color	防错 Coding
1576104	黑色 Black	A
1576105	本色 Natural	B
1576106	棕色 Brown	C
1576007 (TPA)	本色 Natural	

○ 插座护套 / Female Housing

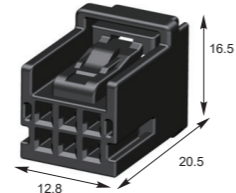

零件号 Part No.	颜色 Color	防错 Coding
1576301	黑色 Black	A
1576302	灰色 Gray	B
1576303	棕色 Brown	C

○ 插头护套 / Male Housing

10线

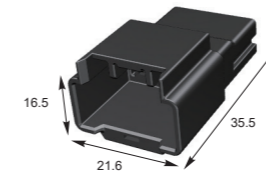

适配A型卡扣/Mating Type A Clip

零件号 Part No.	颜色 Color	防错 Coding
1576401	黑色 Black	A
1576402	灰色 Gray	B
1576403	棕色 Brown	C

推荐位置：车身对接、信号传输、电源等
Recommended Location: body docking, signal transmission or power supply

○ 插头护套 / Male Housing

14线

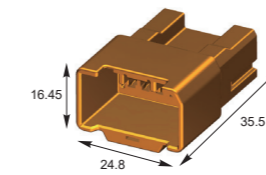

适配A型卡扣/Mating Type A Clip

零件号 Part No.	颜色 Color	防错 Coding
1576601	黑色 Black	A
1576602	灰色 Gray	B
1576603	棕色 Brown	C

推荐位置：车身对接、信号传输、电源等
Recommended Location: body docking, signal transmission or power supply

○ 插头护套 / Male Housing

20线

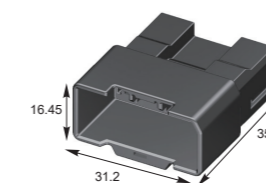

适配A型卡扣/Mating Type A Clip

零件号 Part No.	颜色 Color	防错 Coding
1576801	黑色 Black	A
1576802	灰色 Gray	B
1576803	棕色 Brown	C

推荐位置：车身对接、信号传输、电源等
Recommended Location: body docking, signal transmission or power supply

○ 插座护套 / Female Housing

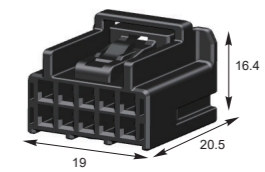

零件号 Part No.	颜色 Color	防错 Coding
1576501	黑色 Black	A
1576502	灰色 Gray	B
1576503	棕色 Brown	C

○ 插座护套 / Female Housing

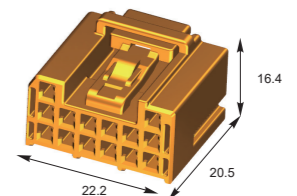

零件号 Part No.	颜色 Color	防错 Coding
1576701	黑色 Black	A
1576702	灰色 Gray	B
1576703	棕色 Brown	C

○ 插座护套 / Female Housing

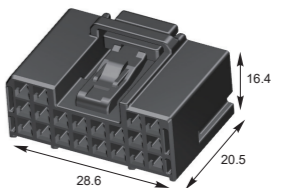

零件号 Part No.	颜色 Color	防错 Coding
1576901	黑色 Black	A
1576902	灰色 Gray	B
1576903	棕色 Brown	C

TH-280 非防水护套 / TH-280 Unsealed Housing

◎ 产品结构 / Construction

◆ 常规型/Normal



◎ 系列产品 / Series Product

○ 插头护套 / Male Housing

2线

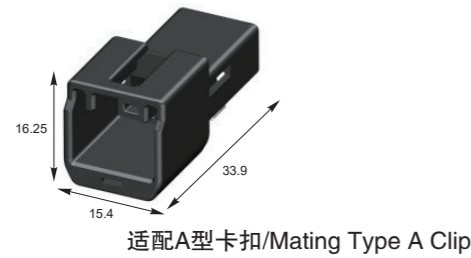

零件号 Part No.	颜色 Color	防错 Coding
1577001	黑色 Black	A
1577002	本色 Natural	B
1577003	棕色 Brown	C

○ 插座护套 / Female Housing

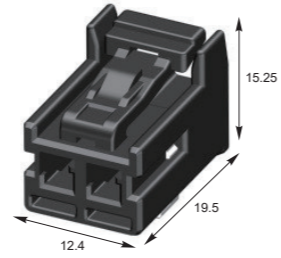

零件号 Part No.	颜色 Color	防错 Coding
1577101	黑色 Black	A
1577102	本色 Natural	B
1577103	棕色 Brown	C

推荐位置：天线、正极滤波器、车身对接、信号传输、电源
Recommended Location: antenna, positive filter, body docking, signal transmission, power supply

○ 插头护套 / Male Housing

4线

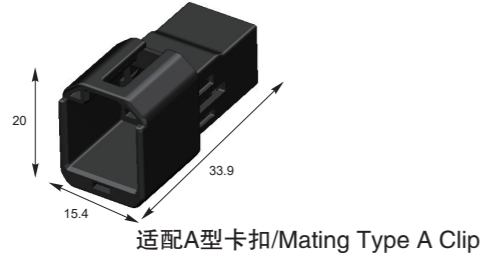

零件号 Part No.	颜色 Color	防错 Coding
1577201	黑色 Black	A
1577202	本色 Natural	B
1577203	棕色 Brown	C

○ 插座护套 / Female Housing

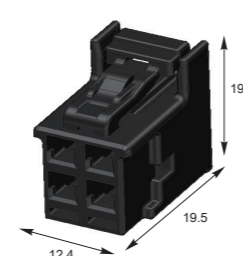

零件号 Part No.	颜色 Color	防错 Coding
1577301	黑色 Black	A
1577302	本色 Natural	B
1577303	棕色 Brown	C

推荐位置：后雨刮、车身对接、信号传输、电源
Recommended Location: rear wiper, body docking, signal transmission, power supply

TH-150+280 混合非防水护套 / TH-150+280 Hybrid Unsealed Housing

◎ 产品结构 / Construction

◆ 常规型/Normal

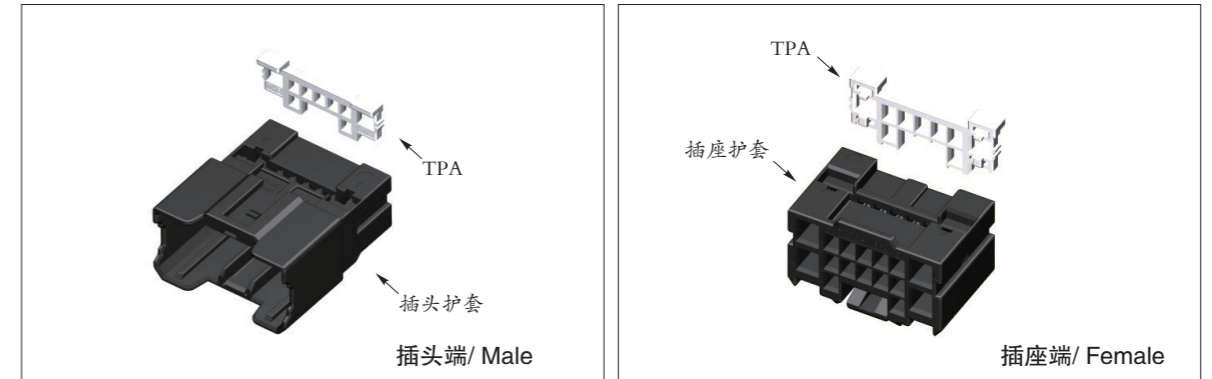

◎ 系列产品 / Series Product

○ 插头护套 / Male Housing

16线 (1.5*0.64x12;2.8*0.8x4)

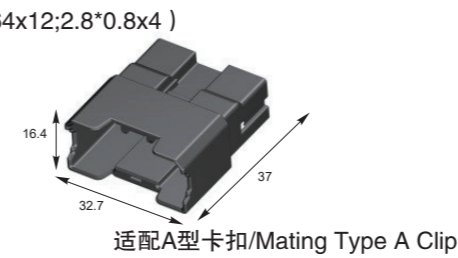

零件号 Part No.	颜色 Color	防错 Coding
1577601	黑色 Black	A
1577602	灰色 Gray	B
1577603	本色 Natural	C

○ 插座护套 / Female Housing

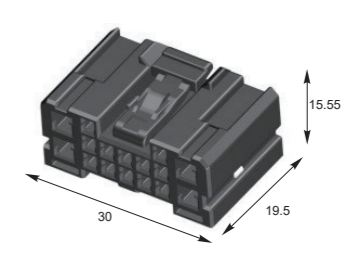

零件号 Part No.	颜色 Color	防错 Coding
1577701	黑色 Black	A
1577702	灰色 Gray	B
1577703	本色 Natural	C

推荐位置：座椅、天窗、车身对接、信号传输、电源
Recommended Location: seat, sunroof, body docking, signal transmission, power supply

TH-064+150+280 混合非防水护套 / TH-064+150+280 Hybrid Unsealed Housing

◎ 产品结构 / Construction

◆ 非助力型 / Non-assist

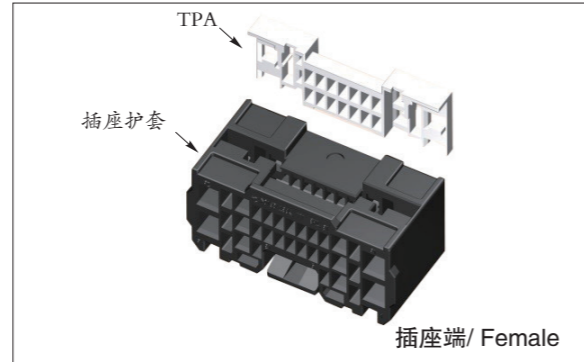
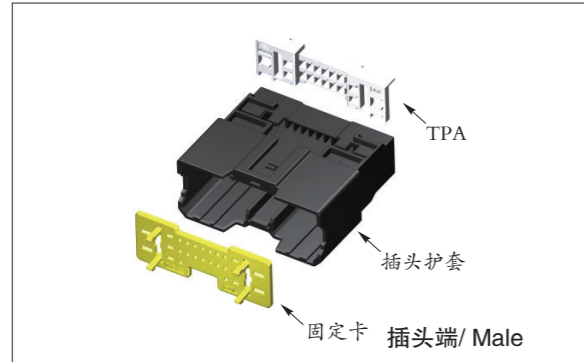

◆ 助力型 // Assist

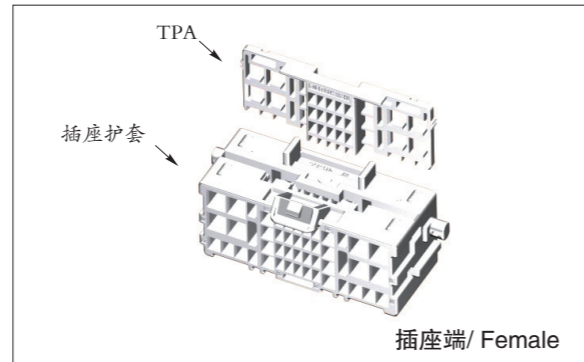

◎ 系列产品 / Series Product

○ 插头护套 / Male Housing

26线 (0.64*0.64x16;1.5*0.64x6;2.8*0.8x4)

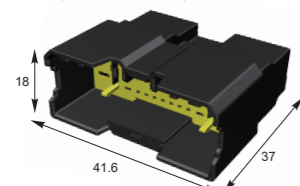

适配A型卡扣 / Mating Type A Clip

零件号 Part No.	颜色 Color	防错 Coding	零件号 Part No.	颜色 Color	防错 Coding
1563301	黑色 Black	A	1563201	黑色 Black	A
1563302	灰色 Gray	B	1563202	灰色 Gray	B
1563303	棕色 Brown	C	1563203	棕色 Brown	C
1563304	绿色 Green	D	1563204	绿色 Green	D
1563305	蓝色 Blue	E	1563205	蓝色 Blue	E
1563306	本色 Natural	F	1563206	本色 Natural	F
1563314	黑色 Black	A			

推荐位置：车身对接、仪表、前舱、信号传输、电源
Recommended Location: body docking, instrument, front compartment, signal transmission, power supply

○ 插座护套 / Female Housing

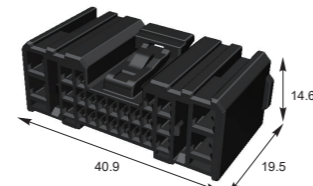

○ 插头护套 / Male Housing

37线 (0.64*0.64x31;1.5*0.64x4;2.8*0.64x2)

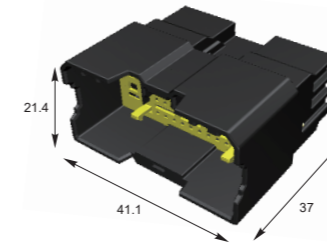

○ 插座护套 / Female Housing

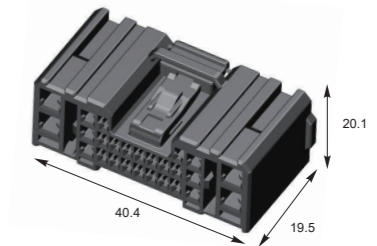

适配A型卡扣 / Mating Type A Clip

零件号 Part No.	颜色 Color	防错 Coding	零件号 Part No.	颜色 Color	防错 Coding
1563601	黑色 Black	A	1563501	黑色 Black	A
1563602	灰色 Gray	B	1563502	灰色 Gray	B
1563603	棕色 Brown	C	1563503	棕色 Brown	C
1563604	绿色 Green	D	1563504	绿色 Green	D
1563605	蓝色 Blue	E	1563505	蓝色 Blue	E
1563606	本色 Natural	F	1563506	本色 Natural	F
1563614	黑色 Black	A	1563514	黑色 Black	A
1563615	灰色 Gray	B	1563515	灰色 Gray	B
1563616	棕色 Brown	C			

推荐位置：车身对接、仪表、前舱、信号传输、电源
Recommended Location: body docking, instrument, front compartment, signal transmission, power supply

○ 插头护套 / Male Housing

42线 (0.64*0.64x20;1.5*0.64x14;2.8*0.8x8)

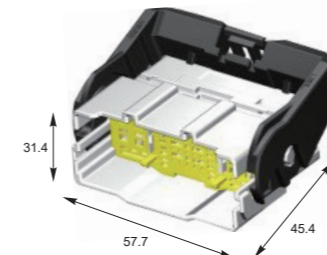

适配B型卡扣 / Mating Type B Clip

零件号 Part No.	颜色 Color	防错 Coding	零件号 Part No.	颜色 Color	防错 Coding
1577401	本色 Natural	A	1577501	本色 Natural	A
1577402	灰色 Gray	B	1577502	灰色 Gray	B
1577403	棕色 Brown	C	1577503	棕色 Brown	C

推荐位置：车身对接、仪表、前舱、信号传输、电源
Recommended Location: body docking, instrument, front compartment, signal transmission, power supply

○ 插座护套 / Female Housing

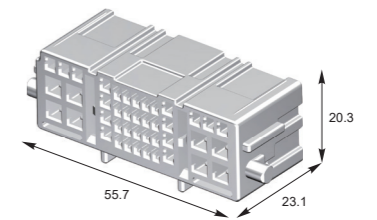

适配辅件 / Accessories

◎ 适配卡扣信息-A型 / Clip Information-Type A

零件号 Part No.	外形尺寸 Size	颜色 Color	适配钣金孔径(mm) Sheet Metal Aperture	适配钣金厚度(mm) Sheet Metal Thickness
1719501		黑色 Black	$\phi 6.1 \sim \phi 7$	1 ~ 3
1720501		黑色 Black	$\phi 6.1 \sim \phi 7$	0.6 ~ 1.6
1721101		黑色 Black	$\phi 7$ (钥匙孔/Keyhole)	1 ~ 3
9700271		黑色 Black	$\phi 7*12$ (长圆孔/Long round hole)	1 ~ 2.3
9700129		黑色 Black	$\phi 7*12$ (长圆孔/Long round hole)	1 ~ 2

◎ 适配卡扣信息-B型 / Clip Information-Type B

零件号 Part No.	外形尺寸 Size	颜色 Color	适配钣金孔径(mm) Sheet Metal Aperture	适配钣金厚度(mm) Sheet Metal Thickness
1720601		黑色 Black	$\phi 7*12$ (长圆孔/Long round hole)	1 ~ 3
1720701		黑色 Black	$\phi 6.5*12.5$ (长圆孔/Long round hole)	1.3 ~ 2.5
1720901		黑色 Black	$\phi 6.5 \sim \phi 7$ (钥匙孔/Keyhole)	1.3 ~ 2.5

◎ 适配卡扣信息-C型 / Clip Information-Type C

零件号 Part No.	外形尺寸 Size	颜色 Color	适配钣金孔径(mm) Sheet Metal Aperture	适配钣金厚度(mm) Sheet Metal Thickness
9700935		黑色 Black	$\phi 7*12$ (长圆孔/Long round hole)	1 ~ 3